

User Manual

PBT1072

(Fold Inward) — — — — ▶

(Back Cover)

(Front Cover)

Compliance Information

FCC Information
This device complies with Part 15 of the FCC Rules.

Caution: Any changes or modifications not expressly approved could void the user's authority to operate the equipment.

Note: This equipment has been tested and found to comply with the limits for a Class B digital device, pursuant to part 15 of the FCC Rules. These limits are designed to provide reasonable protection against harmful interference in a residential installation. This equipment generates, uses and can radiate radio frequency energy and, if not installed and used in accordance with the instructions, may cause harmful interference to radio communications. However, there is no guarantee that interference will not occur in a particular installation. If this equipment does cause harmful interference to radio or television reception, which can be determined by turning the equipment off and on, the user is encouraged to try to correct the interference by one or more of the following measures:

- Reorient or relocate the receiving antenna.
- Increase the separation between the equipment and receiver.
- Connect the equipment into an outlet on a circuit different from that to which the receiver is connected.
- Consult the dealer or an experienced radio/TV technician for help.

This device complies with Part 15 of the FCC Rules. Operation is subject to the following two conditions: (1) This device may not cause harmful interference, and (2) this device must accept any interference received, including interference that may cause undesired operation.

Radiation Exposure Information
The device has been evaluated to meet general RF exposure requirement. The device can be used in portable exposure condition without restriction.

WARNING Li-ion Battery Inside
This product is fitted with a Li-ion battery. Do not damage, open, or dismantle the battery and do not use it in damp and/or corrosive conditions. Use only with compatible chargers. Never dispose of batteries in a fire, and never expose them to high temperatures. Do not expose the product to temperatures exceeding 60°C (140°F).



Rating Label

Definitions

- Direct current symbol.
- This symbol signifies the product must not be discarded as household waste, and should be delivered to an appropriate collection facility for recycling. Proper disposal and recycling helps protect natural resources, human health and the environment.
- This symbol signifies and declares that this equipment has battery charging which complies with California CEC and energy efficiency.
- This symbol signifies that this is a wireless device powered by Bluetooth® technology.
- This symbol represents FCC Declaration of Conformity and compliance.

Warranty Information

90-day Limited Warranty
Territory: United States/Canada

LIMITED WARRANTY TO ORIGINAL CONSUMER
This product (including any accessories included in the original packaging) as supplied and distributed new by an authorized retailer is warranted by Southern Telecom, Inc. to the original consumer purchaser against defects in materials and workmanship ("Warranty") as follows:

To obtain warranty service:

- Visit our customer support portal: www.customersupport123.com
- Select the brand and model of your device.
- Select **Service Request** and fill out the form to begin your inquiry.
- Exchanges require dated proof of purchase from an authorized retailer.

Your product will be repaired or replaced, at our option, for the same or similar model of equal value if examination by the service center determines this product is defective. Products received damaged as a result of shipping will require you to file a claim with the carrier.

Warranty service not provided
This warranty does not cover damage resulting from accident, misuse, abuse, improper installation or operation, lack of reasonable care, unauthorized modification including software modifications such as the installation of custom firmware. This warranty is voided in the event any unauthorized person opens, alters or repairs this product. All products being returned to the authorized service center for repair must be suitably packaged.

NO WARRANTIES, WHETHER EXPRESS OR IMPLIED, INCLUDING, BUT NOT LIMITED TO, ANY IMPLIED WARRANTIES OF MERCHANTABILITY OR FITNESS FOR A PARTICULAR PURPOSE, OTHER THAN THOSE EXPRESSLY DESCRIBED ABOVE SHALL APPLY. DISTRIBUTOR FURTHER DISCLAIMS ALL WARRANTIES AFTER THE EXPRESS WARRANTY PERIOD STATED ABOVE. NO OTHER EXPRESS WARRANTY OR GUARANTY GIVEN BY ANY PERSON, FIRM OR ENTITY WITH RESPECT TO THE PRODUCT SHALL BE BINDING ON DISTRIBUTOR. REPAIR, REPLACEMENT OR REFUND OF THE ORIGINAL PURCHASE PRICE - AT DISTRIBUTOR'S SOLE DISCRETION - ARE THE EXCLUSIVE REMEDIES OF THE CONSUMER. IN NO EVENT WILL DISTRIBUTOR OR ITS MANUFACTURERS BE LIABLE FOR ANY INCIDENTAL, DIRECT, INDIRECT, SPECIAL, PUNITIVE OR CONSEQUENTIAL DAMAGES (SUCH AS, BUT NOT LIMITED TO, DAMAGES FOR LOSS OF PROFITS, BUSINESS, SAVINGS, DATA OR RECORDS) CAUSED BY THE USE, MISUSE OR INABILITY TO USE THE PRODUCT, EXCEPT AS STATED HEREIN. NO OTHER WARRANTIES SHALL APPLY. NOTWITHSTANDING THE FOREGOING, CONSUMER'S RECOVERY AGAINST DISTRIBUTOR SHALL NOT EXCEED THE PURCHASE PRICE OF THE PRODUCT SOLD BY DISTRIBUTOR. THIS WARRANTY SHALL NOT EXTEND TO ANYONE OTHER THAN THE ORIGINAL CONSUMER WHO PURCHASED THE PRODUCT AND IS NOT TRANSFERABLE.

Some countries, states or provinces do not allow the exclusion or limitation of incidental or consequential damages or allow limitations on warranties, so limitation or exclusions may not apply to you. This warranty gives you specific legal rights, and you may have other rights that vary from state to state or province to province. Contact your authorized retailer to determine if another warranty applies.

Designed in US
Printed in China
v1. 02-2021

Polaroid



 **Have questions? We've got answers.**
Visit us at customersupport123.com

 Instantly recognizable. Instantly reassuring. The Polaroid Classic Border and Polaroid Color Spectrum logos let you know you've purchased a product that exemplifies the best qualities of our brand and that contribute to our rich heritage of quality and innovation.

©2021. All rights reserved.
Polaroid, Polaroid Color Spectrum and Polaroid Classic Border Logo are trademarks of PLR IP Holdings, LLC. used under license. PLR IP Holdings LLC, does not manufacture this product or provide any manufacturer's warranty or support.

All product names, trademarks, and registered trademarks are property of their respective owners. All company, product, and service names used in this document are for identification purposes only. Use of these names, trademarks, and brands does not imply endorsement.

Polaroid



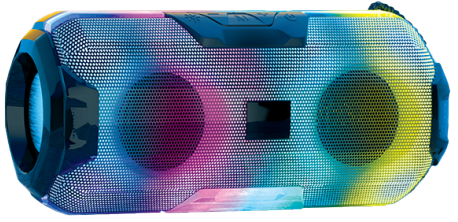

PBT1072
Portable Wireless Party Speaker
User Manual

Before You Begin...

READ CAREFULLY AND KEEP THIS MANUAL

Customer Support
For any questions or problems with your product, please visit our website at customersupport123.com.

Caution
To ensure safe and proper use, read all safety information before using the device. Only use with manufacturer-approved batteries, chargers, accessories, and supplies.

- **THIS DEVICE IS NOT A TOY.** Keep away from children and pets.
- Do not disassemble, modify, or repair the device.
- Do not expose to extreme temperatures (heat or cold), open flames, humid, or wet conditions.
- **Do not submerge in water.**
- Low power may cause poor Bluetooth connection or sound distortion.
- Do not overcharge battery.
- If using with a USB adapter, make sure the adapter is not damaged.
- Do not allow the USB port or the connectors of the supplied USB cable to be exposed to dust or water, or to come into contact with any conductive materials such as liquids, metallic powders, etc.
- The speaker contains a built-in battery and should not be disposed of with regular household waste. Please consult the local authorities on the correct way to dispose of this device.

In the Box

- PBT1072 - **Wireless Speaker** (x1)
- 2-in-1 Charging & AUX Cable (x1)
- User Manual (x1)

Location of Controls

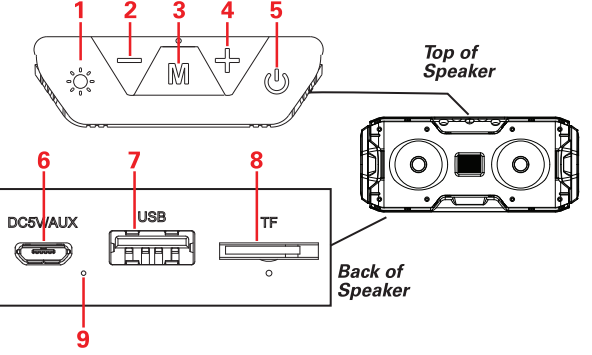

Top of Speaker

Back of Speaker

1. Button: Switch LED mode
2. Button: Press: Skip to previous track Press+hold: Decrease volume
3. Button: Change input mode
4. Button: Press: Skip to next track Press+hold: Increase volume
5. Button: Press: Play/pause, Scan stations (FM mode) Press+hold: Power ON/OFF
6. Charging/AUX Port
7. USB Device Input
8. TF Card Slot
9. LED Indicator

Getting Started

Charging the Speaker

Plug the micro-USB connector of the included 2-in-1 charging & AUX cable into the charging/AUX port on the speaker. Plug the USB (largest) connector into a USB power source such as the USB port on a computer, or into a **5V USB adapter** (not included) and plug into a wall outlet.

The LED indicator will **turn RED** while charging and turn OFF when fully charged. When the speaker is low on power, a tone will be heard indicating that it needs to be recharged.

Powering ON/OFF

- Press + hold the button to power the speaker ON or OFF.
- When powered ON, the speaker will enter Bluetooth pairing mode, and may automatically re-pair to any available previously-paired device nearby.

Adjusting Volume & Playback

- Press the to pause playback. Press again to resume.
- Press the button to skip to the **next** track/station.
- Press the button to skip to the **previous** track/station.
- Press + hold the and buttons to adjust volume.

Note: In AUX mode, all playback will be controlled by your connected device.

Changing Input Modes

Press the button on the speaker to switch input modes.

A TF card or USB device must be inserted or connected to switch to these modes.

Using the LED Lights

The speaker LED lights will automatically power ON/OFF with the speaker.

- Press the button to switch between the different LED light modes.

Bluetooth Pairing

1. Power the speaker ON. A tone will be heard and the speaker will enter Bluetooth pairing mode. The LED indicator will light up solid BLUE.
2. Set your mobile device to search for Bluetooth devices. When it appears, select **PBT1072** from the list of found devices.
3. After a successful pairing, a tone will be heard and you will be able to play music on the speaker.

Using the AUX Input

Plug the micro-USB connector of the included 2-in-1 charging & AUX cable into the charging/AUX port on the speaker. Plug the 3.5 mm connector into the headphone jack or 3.5 mm AUX output port on your media-playing device.

Switch input modes until you reach AUX mode. In AUX mode, all playback will be controlled by your connected device.

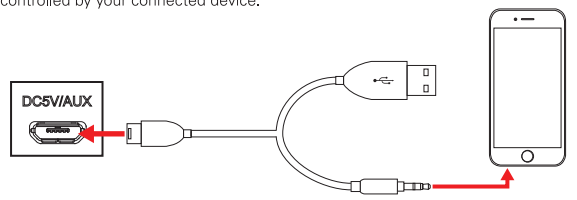

Using the FM Radio

Change input modes until you enter FM radio mode.

In FM radio mode, playback will be controlled by the buttons on the speaker.

- Press the button to start or stop automatically scanning and saving nearby FM radio stations. If not stopped, the radio to make a complete scan and save of all available radio stations, and return to the first saved station.
- Press the and buttons to skip through saved stations.

Using a TF Card or USB Device

To insert a TF card, insert a TF card into the TF card slot on the speaker with the metal contacts facing down, and push in until it clicks.

To insert a USB device, such as a USB flash drive containing audio files, insert the USB device into the USB device port on the speaker.

Change input modes until you enter TF or USB mode. The speaker will automatically begin playing music off the device. **Note:** You must have a TF card or USB device inserted to switch to TF or USB input mode.

In TF card and USB mode, all playback is controlled by the buttons on the speaker.