

Brookstone®

---

# ACTIVETUNE

True Wireless Earbuds



# TABLE OF CONTENTS

Compliance Information.....	1
Before You Begin...	
Additional Warnings.....	3
In the Box.....	3
Location of Controls.....	4
Getting Started	
Charging the Case.....	5
Charging the Earbuds.....	5
Powering ON/OFF.....	6
Bluetooth Pairing.....	7
Controlling Playback.....	8
Adjusting the Volume.....	8
Phone Calls.....	8
Activating Siri® or Voice Assistant.....	9
Storage & Maintenance.....	9
Specifications.....	9
Warranty Information.....	10

## **FCC Information**

This device complies with Part 15 of the FCC Rules.

**Caution:** Any changes or modifications not expressly approved could void the user's authority to operate the equipment.

**Note:** This equipment has been tested and found to comply with the limits for a Class B digital device, pursuant to part 15 of the FCC Rules. These limits are designed to provide reasonable protection against harmful interference in a residential installation. This equipment generates, uses and can radiate radio frequency energy and, if not installed and used in accordance with the instructions, may cause harmful interference to radio communications. However, there is no guarantee that interference will not occur in a particular installation. If this equipment does cause harmful interference to radio or television reception, which can be determined by turning the equipment off and on, the user is encouraged to try to correct the interference by one or more of the following measures:

- Reorient or relocate the receiving antenna.
- Increase the separation between the equipment and receiver.
- Connect the equipment into an outlet on a circuit different from that to which the receiver is connected.
- Consult the dealer or an experienced radio/TV technician for help.

This device complies with Part 15 of the FCC Rules. Operation is subject to the following two conditions: (1) This device may not cause harmful interference, and (2) this device must accept any interference received, including interference that may cause undesired operation.

## **Radiation Exposure Information**

This device has been evaluated to meet general RF exposure requirements. The device can be used in portable exposure conditions without restriction.

## LITHIUM POLYMER BATTERY WARNINGS

This device contains a non-removable Lithium-Polymer battery. The battery must be recycled or disposed of properly. Contact your local waste management office for information on battery recycling or disposal.



### Rating Label Definitions

 Direct current symbol.



This symbol signifies the product must not be discarded as household waste, and should be delivered to an appropriate collection facility for recycling. Proper disposal and recycling helps protect natural resources, human health and the environment.



This symbol signifies and declares that this equipment has battery charging which complies with California CEC and energy efficiency.



This symbol signifies that this is a wireless device powered by Bluetooth® technology. The Bluetooth® word mark and logos are registered trademarks owned by Bluetooth SIG, Inc., used under license.



This symbol represents FCC Declaration of Conformity and compliance.

Before You Begin...

## **READ THIS MANUAL CAREFULLY AND SAVE FOR FUTURE REFERENCE**

To ensure safe and proper use, read all safety information before using the device. Only use with manufacturer-approved batteries, chargers, accessories, and supplies.

- **THIS DEVICE IS NOT A TOY**, do NOT allow children or pets to use or play with this device.
- **Do not disassemble, modify, or repair the device.**
- Do not expose the device to extreme temperatures (heat or cold), open flames, humid, or wet conditions.
- **Do not submerge in water.**
- Low power may cause poor Bluetooth connection or sound distortion.
- Do not overcharge battery.
- If using with a USB adapter, make sure the adapter is not damaged.
- Do not allow the USB port or the connectors of the supplied USB cable to be exposed to dust, or water, or come into contact with any conductive materials such as liquids, metallic powders, etc.
- The earbuds & charging case contain a built-in battery and should not be disposed of with regular household waste. Please consult the local authorities on the correct way to dispose of these devices.
- ***Always be aware of your surroundings when using the earbuds***
- ***Never use earbuds while driving a vehicle, riding a bicycle, or operating anything that requires your undivided attention***

In the Box

- BSTWS30 - True Wireless Earbuds (L & R)
- Charging Case (x1)
- USB Type-C Charging Cable (x1)
- Instruction Manual (x1)

## Location of Controls

### **[Multi]** Touch Button

- Power On/Off
- Pause/Resume Playback
- Skip Tracks
- Adjust Volume
- Answer/End Phone Calls
- Reject Phone Calls
- Wake Voice Assistant

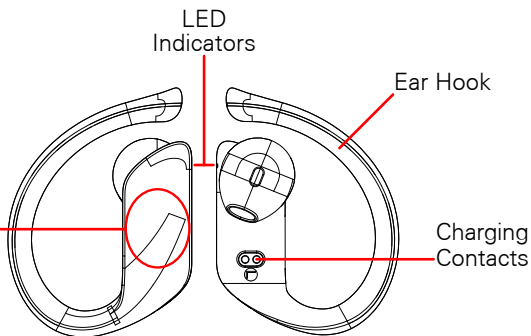

## Charging Case

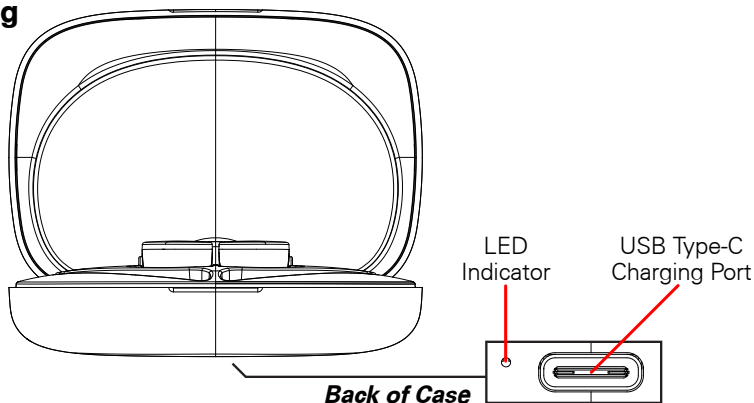

## Charging the Case

Insert the small connector of the included charging cable into the charging port on the charging case. Insert the larger connector into a USB power source such as the USB port on a computer, or a 5V/1A USB wall adapter (*not included*).

The LED indicator on the case will light up RED while the case is charging, and turn OFF when it is finished charging.

The LED indicator will flash when the case is low on battery. Please recharge when this happens.

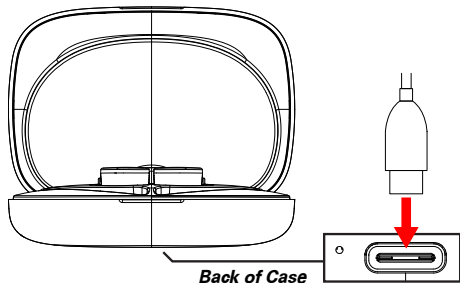

## Charging the Earbuds

Use the included charging case to protect and charge your earbuds.

To charge the earbuds, open the case. Place the earbuds into the correct earbud charging ports. The earbuds will automatically power OFF and begin charging.

The earbuds' LED indicators will turn RED while they are charging and turn OFF when they are fully charged.

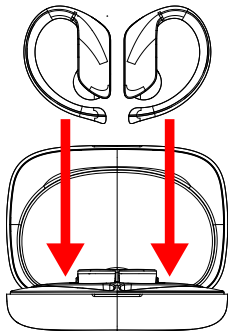

## Powering On/Off

### **Charge the case and earbuds fully before using.**

- Remove the earbuds from the case to automatically power them ON. The earbuds' LED indicators will **flash RED and BLUE**. When both earbuds are powered ON at the same time they will automatically pair to each other after a few seconds.
- Insert the earbuds into the case to automatically power them OFF. The earbuds' LED indicators will **quickly flash RED** when they are powering OFF.
- The earbuds can also be powered ON and OFF by *touching + holding* the earbuds' **[Multi]** buttons for **3s. (power ON)** or **5s. (power OFF)**.

**Note:** The earbuds will automatically power OFF if they are not paired to a Bluetooth device after 2 minutes, or if the paired device is out of Bluetooth range (10 m / 30 ft) for 5 minutes.

**Note:** Either earbud can be used independently.

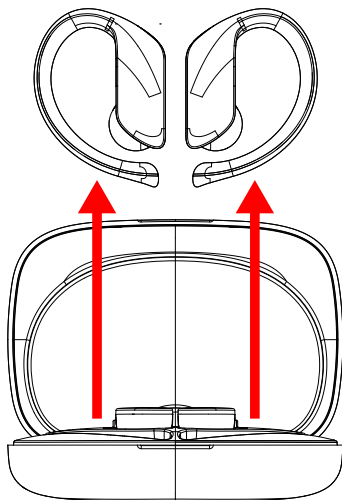



## Bluetooth Pairing

1. Power the earbuds ON at the same time. The LED indicators on both earbuds will **flash RED and BLUE**. After a few seconds, a tone should be heard and the LED indicators will flash slowly, indicating that the earbuds have connected to each other. **If the earbuds don't connect to each other, see the troubleshooting section at the bottom of this page.**
2. Open your device's Bluetooth menu and select **BSTWS30** when it appears.
3. Another tone will be heard, indicating that the earbuds are successfully connected to your device. The LED indicators on both earbuds will **turn OFF**.

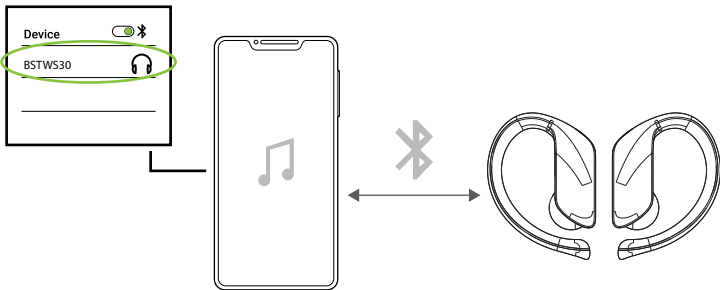

### Trouble Pairing the Earbuds to Each Other? Try these steps:

1. Place both earbuds back into the case to power them OFF.
2. You may need to go into your device's Bluetooth settings and manually **"Forget"** one or both of the earbuds, and turn your device's Bluetooth OFF while the earbuds pair to each other.
3. Turn your device's Bluetooth back ON if necessary, and follow the **Bluetooth Pairing** steps above again.

## Controlling Playback

- **2x Touch** the **[Multi]** button on either earbud to pause and resume audio playback.
- **Touch + hold for 1.5s** the **[Multi]** button on the **left** earbud to skip to the **previous** track.
- **Touch + hold for 1.5s** the **[Multi]** button on the **right** earbud to skip to the **next** track.

## Adjusting the Volume

- **1x Touch** the **[Multi]** button on the **right** earbud to **increase** volume.
- **1x Touch** the **[Multi]** button on the **left** earbud to **decrease** volume.

## Phone Calls

- **1x Touch** the **[Multi]** button on either earbud to **answer** an incoming phone call. Touch again to **end** the phone call.
- **Touch + hold (2s.)** the **[Multi]** button on either earbud **for 2 seconds** to reject an incoming phone call.

### Left Earbud

**1x Touch:** Decrease volume

**Touch + hold (1.5s):** Skip to previous track

### Right Earbud

**1x Touch:** Increase volume

**Touch + hold (1.5s):** Skip to next track

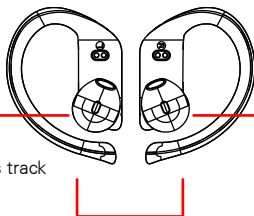

### Either Earbud

**2x Touch:** Pause/resume playback

**1x Touch:** Answer/end phone call

**Touch + hold (2s.):** Reject incoming call

**3x Touch:** Activate voice assistant

## Activating Siri® or Voice Assistant

If you have Siri® or another voice assistant on your paired device, you can activate it using the controls on the earbuds or the controls on your device.

- **3x Touch** either earbud's **[Multi]** button to **activate** voice assistant.

## Storage & Maintenance

When not using the earbuds, it is recommended that they are stored away in the charging case and placed in a safe, dry location, away from sources of water, light, heat, and dust. They are best stored in an airtight box or bag (*not included*).

If the earbuds or case is dirty, wipe it down with a **clean microfiber cloth**. Do not clean with water or any sort of cleaning liquid or detergent.

## Specifications

### **TWS Earbuds**

Bluetooth Ver.: 5.0

Bluetooth Range: 33 ft

Talk & Play Time: Up to 3 hrs

Single Earbud Battery Capacity: 30 mAh

### **Charging Case**

Charging Case Battery Capacity: 300 mAh

Input Type: USB Type-C

## Warranty Information

### **90-Day Limited Warranty**

Territory: United States/Canada

### **LIMITED WARRANTY TO ORIGINAL CONSUMER**

This product as supplied and distributed new by an authorized retailer is warranted by Southern Telecom, Inc. to the original consumer purchaser against defects in materials and workmanship ("Warranty") as follows:

#### **To obtain warranty service:**

- Visit our customer support portal: **[www.customersupport123.com](http://www.customersupport123.com)**
- Select the brand and model of your device
- Select "Service Request" and fill out the form to begin your inquiry
- Exchanges require dated proof of purchase from an authorized retailer

Your product will be repaired or replaced, at our option, for the same or similar model of equal value if examination by the service center determines this product is defective. Products received damaged as a result of shipping will require you to file a claim with the carrier.

#### **Warranty service not provided**

This warranty does not cover damage resulting from accident, misuse, abuse, improper installation or operation, lack of reasonable care, unauthorized modification including software modifications such as the installation of custom firmware. This warranty is voided in the event any unauthorized person opens, alters or repairs this product. All products being returned to the authorized service center for repair must be suitably packaged.

## Warranty (cont'd)

NO WARRANTIES, WHETHER EXPRESS OR IMPLIED, INCLUDING, BUT NOT LIMITED TO, ANY IMPLIED WARRANTIES OF MERCHANTABILITY OR FITNESS FOR A PARTICULAR PURPOSE, OTHER THAN THOSE EXPRESSLY DESCRIBED ABOVE SHALL APPLY. DISTRIBUTOR FURTHER DISCLAIMS ALL WARRANTIES AFTER THE EXPRESS WARRANTY PERIOD STATED ABOVE. NO OTHER EXPRESS WARRANTY OR GUARANTY GIVEN BY ANY PERSON, FIRM OR ENTITY WITH RESPECT TO THE PRODUCT SHALL BE BINDING ON DISTRIBUTOR. REPAIR, REPLACEMENT, OR REFUND OF THE ORIGINAL PURCHASE PRICE - AT DISTRIBUTOR'S SOLE DISCRETION - ARE THE EXCLUSIVE REMEDIES OF THE CONSUMER. IN NO EVENT WILL DISTRIBUTOR OR ITS MANUFACTURERS BE LIABLE FOR ANY INCIDENTAL, DIRECT, INDIRECT, SPECIAL, PUNITIVE OR CONSEQUENTIAL DAMAGES (SUCH AS, BUT NOT LIMITED TO, DAMAGES FOR LOSS OF PROFITS, BUSINESS, SAVINGS, DATA OR RECORDS) CAUSED BY THE USE, MISUSE OR INABILITY TO USE THE PRODUCT. EXCEPT AS STATED HEREIN, NO OTHER WARRANTIES SHALL APPLY. NOTWITHSTANDING THE FOREGOING, CONSUMER'S RECOVERY AGAINST DISTRIBUTOR SHALL NOT EXCEED THE PURCHASE PRICE OF THE PRODUCT SOLD BY DISTRIBUTOR. THIS WARRANTY SHALL NOT EXTEND TO ANYONE OTHER THAN THE ORIGINAL CONSUMER WHO PURCHASED THE PRODUCT AND IS NOT TRANSFERABLE.

Some countries, states or provinces do not allow the exclusion or limitation of incidental or consequential damages or allow limitations on warranties, so limitation or exclusions may not apply to you. This warranty gives you specific legal rights, and you may have other rights that vary from state to state or province to province. Contact your authorized retailer to determine if another warranty applies.

All product names, trademarks, and registered trademarks are property of their respective owners. All company, product, and service names used in this document are for identification purposes only. Use of these names, trademarks, and brands does not imply endorsement.

The Bluetooth® word mark and logos are registered trademarks owned by Bluetooth SIG, Inc., used under license.

Printed in China  
v1. 09-2021

# Brookstone®

Brookstone® trademark, name and logos are trademarks of BKST Brand Holdings LLC and used under license.

Manufactured and Marked by Southern Telecom, Inc. under license.

Southern Telecom  
Brooklyn, NY 11220

Model No.: BSTWS30