

Better Homes & Gardens®

PIERCED CERAMIC
ULTRASONIC DIFFUSER
AQUIFER



User Manual
BH1228063978001

Before You Begin...

Caution

To ensure safe and proper use, read all safety information before using the device. Only use with manufacturer-approved batteries, chargers, accessories, and supplies.

• **NOT INTENDED FOR MEDICAL USE**

- This device is not intended to be a substitute for medical attention.
- The amount and intensity of aroma produced will vary. Factors that affect production of aroma can include water type, humidity, temperature, air current, and/or type or brand of essential oil used.
- It may take up to a half-hour before you can smell the essential oil.
- Water Tank Capacity: 180 mL
- Runs up to 4 hours continuously or up to 10 hours of intermittent operation.
- The suggested room size for this device is ~150 ft² (this may vary greatly by environment, type of essential oil used, etc.).
- Only 100% natural essential oil should be used with this product. Oil containing chemical fragrance, spice, or other impurities may cause malfunctions.
- ONLY use the supplied power cable and charger.
- When not in use, the diffuser should be stored in a dry, cool location, away from sources of water or heat.
- It is recommended that the diffuser be covered to protect it from exposure to dust if it will not be in use for a long period of time.

Questions & Support

If you have any questions or problems concerning this product, please visit our customer support portal: www.customersupport123.com and select “**Support**”. Select the brand, fill out the corresponding form, then submit your request.

In the Box

- Aroma Diffuser (x1)
- 5V 2A USB Charger (x1)
- USB Power Cable (x1)
- User Manual (x1)

Location of Controls

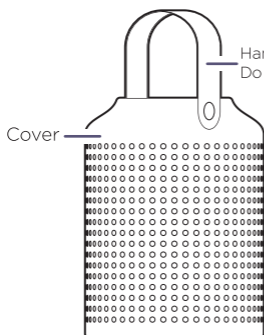

Handle is for décor.
Do not carry by handle.

The product cannot be suspended and can only be used on a flat desktop.

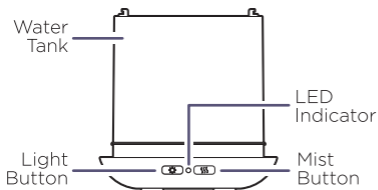
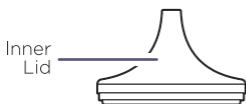

Getting Started

Charging the Diffuser

Charge the diffuser with the USB Power Cable and the USB charger plugged into the wall outlet as shown below.

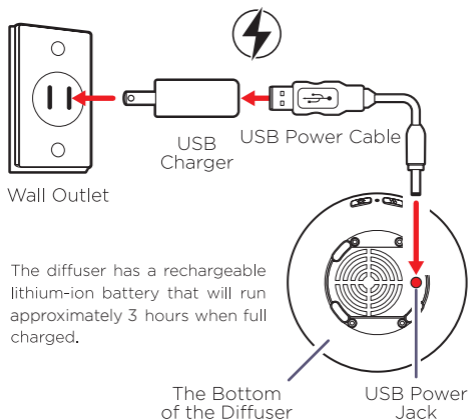

The diffuser has a rechargeable lithium-ion battery that will run approximately 3 hours when full charged.

The LED indicator will flash when the battery needs to be recharged. It takes 7-8 hours to fully recharge the diffuser.



A solid light will indicate that the diffuser is charging and the light will turn off when it is fully charged.



Setup

1. Remove the cover and inner lid.
2. Fill the water tank with room temperature water until the MAX level line is reached.
3. Add 2 - 3 drops (0.1 - 0.15 mL) of essential oil (*not included*).
4. Put the inner lid and cover back on the water tank, and place on a flat, sturdy surface.

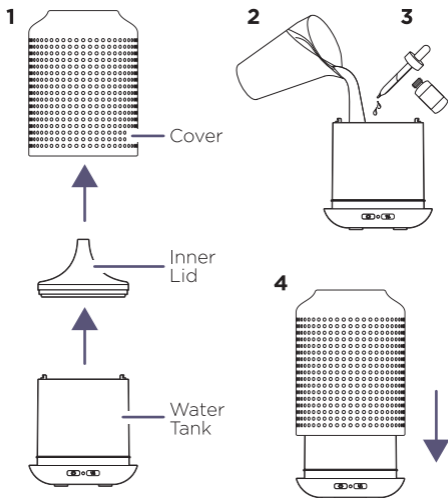

The diffusion function will not operate and auto shut-off when water level runs low.

CAUTION: Using more than the recommended amount of oil may cause the diffuser to get clogged and not operate properly.

Do not drain water from the side of air outlet.

Using the Diffuser

- Press the **[Mist]** button to turn the diffuser on in continuous diffusion mode.
- Press the **[Mist]** button again to change to intermittent diffusion mode. In intermittent diffusion mode, mist will be diffused periodically every 30 seconds. This greatly increases the length of time. The diffuser will operate before the water tank is empty.
- Press the **[Mist]** button a third time to turn the diffuser off.

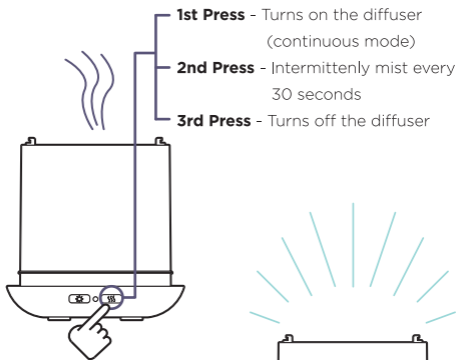

Using the Lights

- Press the **[Light]** button to turn the light on. The light will be dim.
- Press the **[Light]** button a second time to increase the brightness (~60% brightness).
- Press the **[Light]** button a third time to raise the brightness to 100%.
- Press the **[Light]** button a fourth time to turn off.

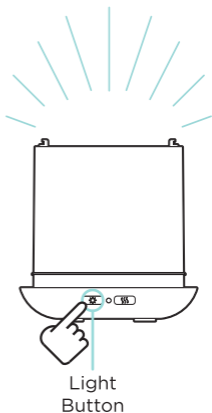

Precautions & Warnings

1. Do not fill over MAX level line.
2. Do not turn the aroma function on when the tank is empty.
3. Do not touch the inside base of the tank.
4. Clean regularly per the instructions in this user manual to avoid malfunctions.
5. Always unplug from power source before maintenance.
6. Always pour any remaining oil out of the tank and wipe with a clean, dry cloth.
7. Essential oils can stain. In the event of a spill or leakage, please wipe away any water or oil with a soft cloth.
8. Do not let aroma blow directly onto furniture, clothing, art, or any valuable objects.
9. Keep away from direct sunlight, heat sources, air conditioners, and fans.
10. Always keep on a stable, flat surface. Do NOT place on a carpet, bed, cushion or other non-flat, non-stable surface.
11. Keep away from electronic equipment.
12. Do not tip the product as it may cause water to enter the mechanism and cause malfunction.
13. Do not use for more than 6 hours at a time.
14. Never move the product while in use.
15. Do not touch any part of the product with wet hands.
16. Keep out of reach of children and pets. Children should not be left unsupervised near this product. This unit is not to be used by children or any person(s) with reduced physical, sensory, or mental capabilities, or lack of experience and knowledge, unless they have been given express supervision and instruction.
17. Keep the power cable clear of pathways, and do not forcefully pull or remove from the unit.
18. If smoke or burning smell is detected, immediately unplug the unit.
19. Handle is for décor. Do not carry by handle.

Legal Information

FCC Information

This device complies with Part 18 of the FCC Rules.

Rating Label Definitions

 Direct Current

 This symbol represents FCC Declaration of Conformity and compliance.

Cleaning the Diffuser

Suggestion: It is recommended to clean the diffuser once a week.

When you are finished using the diffuser, unplug the cable, and drain any remaining water in the tank.

Gently wipe the inside of the tank with a clean cloth or rag to remove any leftover oil. Do NOT use any soap or detergent to clean the water tank.

Carefully clean the nozzle over the ultrasonic pad with a brush or cotton swab.

Do NOT get water inside the air outlet while cleaning the diffuser.



**Do not use any soap,
detergent, or bleach
to clean**

Limited Warranty

1-year Limited Warranty

Territory: United States

LIMITED WARRANTY TO ORIGINAL CONSUMER

This product (including any accessories included in the original packaging) as supplied and distributed new by an authorized retailer is warranted by Southern Telecom, Inc. to the original consumer purchaser against defects in materials and workmanship ("Warranty") as follows:

To obtain warranty service:

- Visit our customer support portal www.customersupport123.com and select "Support".
- Select the brand, fill out the corresponding form (exchanges require dated proof of purchase from an authorized retailer) then submit your request.

Your product will be repaired or replaced, at our option, for the same or similar model of equal value if examination by the service center determines this product is defective. Products received damaged as a result of shipping will require you to file a claim with the carrier.

Warranty service not provided

This warranty does not cover damage resulting from accident, misuse, abuse, improper installation or operation, lack of reasonable care, unauthorized modification including software modifications such as the installation of custom firmware. This warranty is voided in the event any unauthorized person opens, alters or repairs this product. All products being returned to the authorized service center for repair must be suitably packaged.

NO WARRANTIES, WHETHER EXPRESS OR IMPLIED, INCLUDING, BUT NOT LIMITED TO, ANY IMPLIED WARRANTIES OF MERCHANTABILITY OR FITNESS FOR A PARTICULAR PURPOSE, OTHER THAN THOSE EXPRESSLY DESCRIBED ABOVE SHALL APPLY. DISTRIBUTOR FURTHER DISCLAIMS ALL WARRANTIES AFTER THE EXPRESS WARRANTY PERIOD STATED ABOVE. NO OTHER EXPRESS WARRANTY OR GUARANTY GIVEN BY ANY PERSON, FIRM OR ENTITY WITH RESPECT TO THE PRODUCT SHALL BE BINDING ON DISTRIBUTOR. REPAIR, REPLACEMENT, OR REFUND OF THE ORIGINAL PURCHASE PRICE - AT DISTRIBUTOR'S SOLE DISCRETION - ARE THE EXCLUSIVE REMEDIES OF THE CONSUMER. IN NO EVENT WILL DISTRIBUTOR OR ITS MANUFACTURERS BE LIABLE FOR ANY INCIDENTAL, DIRECT, INDIRECT, SPECIAL, PUNITIVE OR CONSEQUENTIAL DAMAGES (SUCH AS, BUT NOT LIMITED TO, DAMAGES FOR LOSS OF PROFITS, BUSINESS, SAVINGS, DATA OR RECORDS) CAUSED BY THE USE, MISUSE OR INABILITY TO USE THE PRODUCT. EXCEPT AS STATED HEREIN, NO OTHER WARRANTIES SHALL APPLY, NOTWITHSTANDING THE FOREGOING. CONSUMER'S RECOVERY AGAINST DISTRIBUTOR SHALL NOT EXCEED THE PURCHASE PRICE OF THE PRODUCT SOLD BY DISTRIBUTOR. THIS WARRANTY SHALL NOT EXTEND TO ANYONE OTHER THAN THE ORIGINAL CONSUMER WHO PURCHASED THE PRODUCT AND IS NOT TRANSFERABLE.

Some countries, states or provinces do not allow the exclusion or limitation of incidental or consequential damages or allow limitations on warranties, so limitation or exclusions may not apply to you. This warranty gives you specific legal rights, and you may have other rights that vary from state to state or province to province. Contact your authorized retailer to determine if another warranty applies.

Better Homes & Gardens®

All product names, trademarks, and registered trademarks are property of their respective owners. All company, product, and service names used in this document are for identification purposes only. Use of these names, trademarks, and brands does not imply endorsement.

Printed in China
Designed in the U.S.
v1. 11/2021