



CIPTON[®]

**LED LIGHT UP
SMASH BALL
PRO SERIES
CPOG112**





WARNING:

CHOKING HAZARD - Small parts.
Not for children under 3 years.



ATTENTION:

RISQUE D'ÉTOUFFEMENT - Petites pièces.
Ne convient pas aux enfants de moins de 3 ans.

Warning: Adult supervision required. Please read full manual before use.

ASSEMBLY INSTRUCTIONS INSTRUCTIONS DE MONTAGE

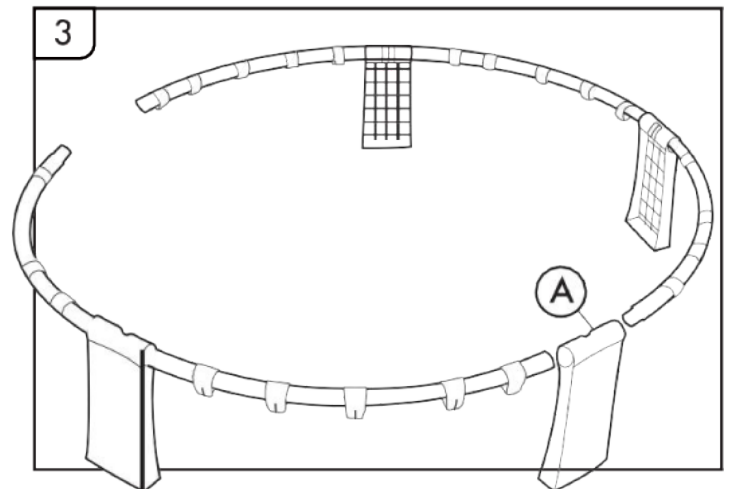
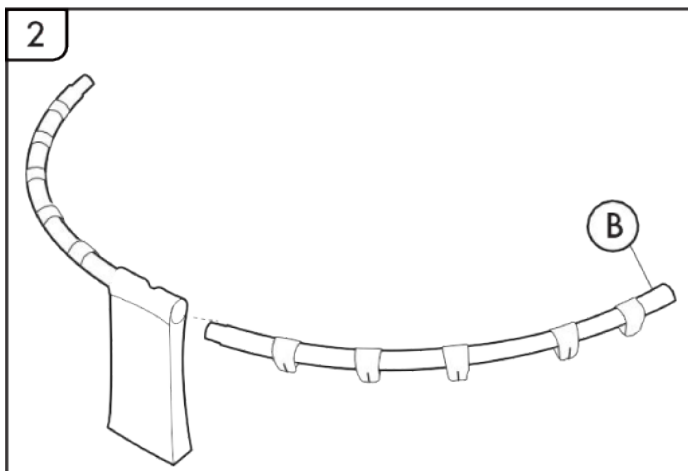
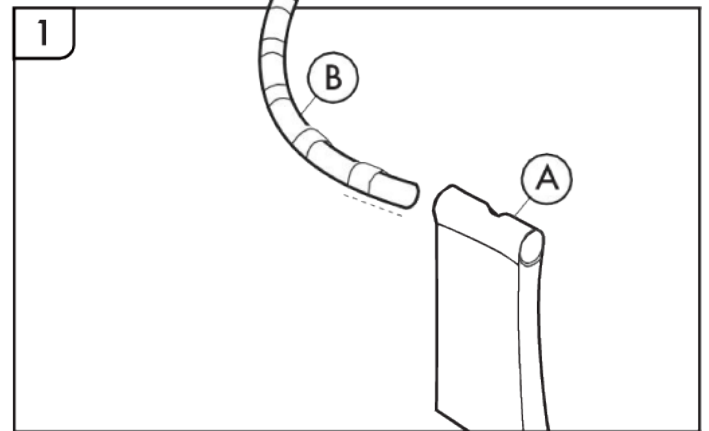
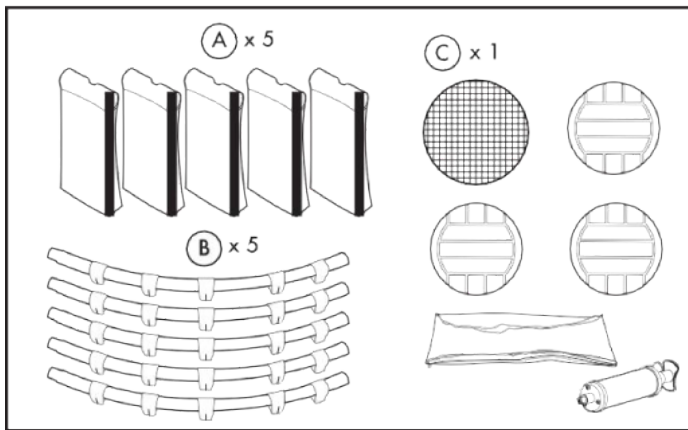

Continued on the next page.

ASSEMBLY (CONT'D)

4

Install & activate the LED lights on the edges of the playing frame:

1. Install the orange LED light strips along the edges of the playing frame using the built-in hook-and-loop fasteners.



2. Remove the plastic pull tabs from the battery packs of the light units.

3. Press the buttons on the battery packs to power the LED lights ON.

5

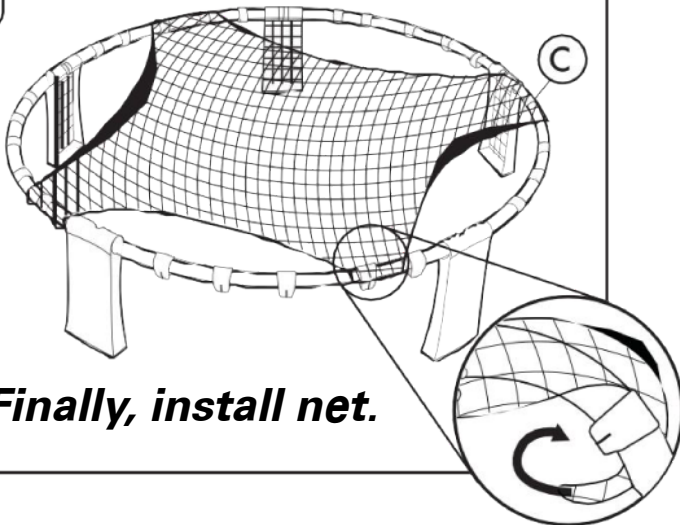

Finally, install net.

6

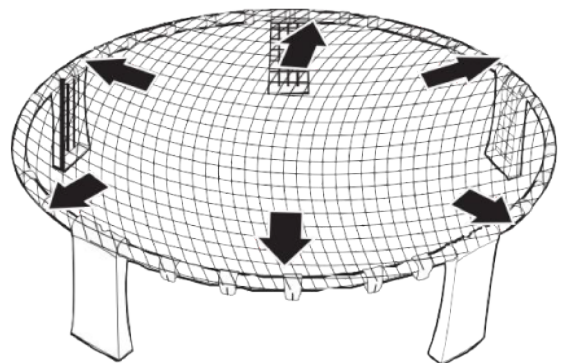

Once completed with setup, see the game rules on the next page.

GAME RULES

REGLES DU JEU

5+



TEAM 1
ÉQUIPE 1

2 TEAMS OF 2
2 ÉQUIPES DE

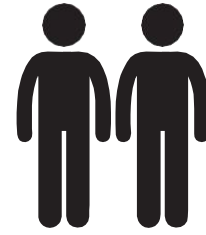
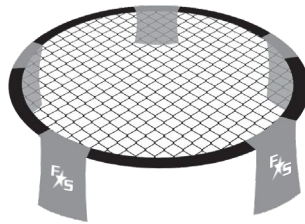

TEAM
ÉQUIPE

SERVE ALIMENTER

GAME STARTS BY TEAM 1 SERVING
JEU COMMENCE PAR L'ÉQUIPE 1 PORTION

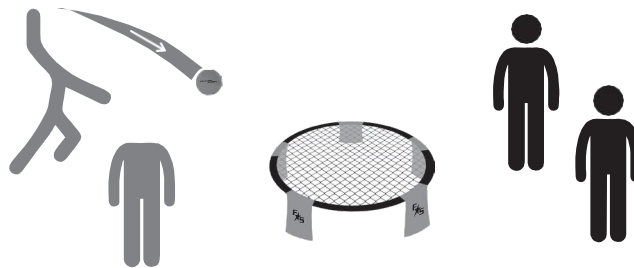

All players except the receiver must begin the point at least 6 feet from the net. The receiver may stand at any desired distance

Tous les joueurs sauf le récepteur doivent commencer le point à au moins 6 pieds du filet. Le récepteur peut se tenir à une distance quelconque souhaitée

RETURNS RETOURNER

PLAYERS HAVE UP TO 3 ALTERNATING HITS TO RETURN THE BALL TO THE NET
LES JOUEURS ONT JUSQU'A 3 HITS ALTERNATIF POUR RETOURNER LE BALLON AU NET

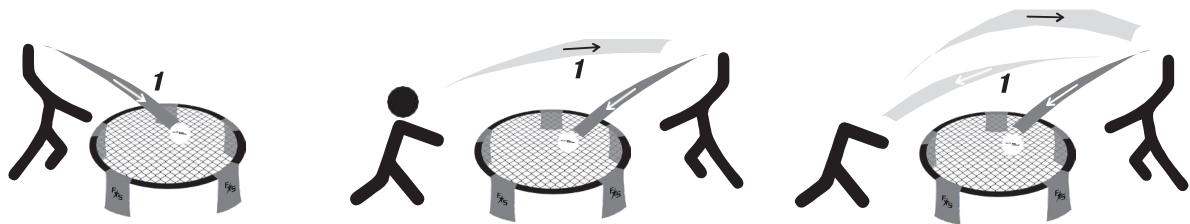

AFTER SERVE, PLAYERS CAN MOVE OR HIT IN ANY DIRECTION
APRÈS SERVIR, LES JOUEURS PEUVENT SE DÉPLACER OU FRAPPER DANS TOUTES LES DIRECTIONS

POINTS ARE WON WHEN OPPOSING TEAMS BALL:
LES POINTS SONT GAGNÉS QUAND BOULE DE L'ÉQUIPE D'OPPOSITION:

HITS THE RIM
FRAPPE LA RIM

BOUNCES MORE THAN ONCE ON THE NET
BOUNCES PLUS QU'UNE FOIS SUR LE NET

HITS THE GROUND
FRAPPE SOL

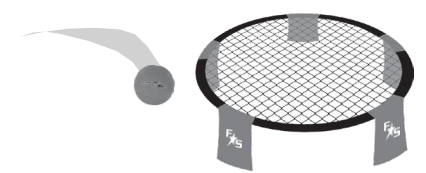
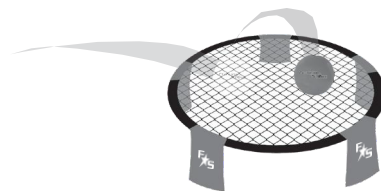
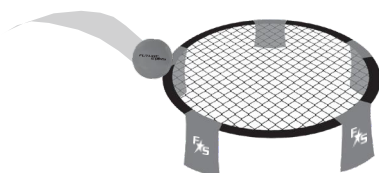

90-Day Limited Warranty

Territory: United States/Canada

LIMITED WARRANTY TO ORIGINAL CONSUMER

This product as supplied and distributed new by an authorized retailer is warranted by Southern Telecom, Inc. to the original consumer purchaser against defects in materials and workmanship ("Warranty") as follows:

To obtain warranty service:

- Visit our customer support portal: www.customersupport123.com and select "**Support**".
- Select the brand, fill out the corresponding form (exchanges require dated proof of purchase from an authorized retailer) then submit your request.

Your product will be repaired or replaced, at our option, for the same or similar model of equal value if examination by the service center determines this product is defective. Products received damaged as a result of shipping will require you to file a claim with the carrier.

Warranty service not provided

This warranty does not cover damage resulting from accident, misuse, abuse, improper installation or operation, lack of reasonable care, unauthorized modification including software modifications such as the installation of custom firmware. This warranty is voided in the event any unauthorized person opens, alters or repairs this product. All products being returned to the authorized service center for repair must be suitably packaged.

NO WARRANTIES, WHETHER EXPRESS OR IMPLIED, INCLUDING, BUT NOT LIMITED TO, ANY IMPLIED WARRANTIES OF MERCHANTABILITY OR FITNESS FOR A PARTICULAR PURPOSE, OTHER THAN THOSE EXPRESSLY DESCRIBED ABOVE SHALL APPLY. DISTRIBUTOR FURTHER DISCLAIMS ALL WARRANTIES AFTER THE EXPRESS WARRANTY PERIOD STATED ABOVE. NO OTHER EXPRESS WARRANTY OR GUARANTY GIVEN BY ANY PERSON, FIRM OR ENTITY WITH RESPECT TO THE PRODUCT SHALL BE BINDING ON DISTRIBUTOR. REPAIR, REPLACEMENT, OR REFUND OF THE ORIGINAL PURCHASE PRICE - AT DISTRIBUTOR'S SOLE DISCRETION - ARE THE EXCLUSIVE REMEDIES OF THE CONSUMER. IN NO EVENT WILL DISTRIBUTOR OR ITS MANUFACTURERS BE LIABLE FOR ANY INCIDENTAL, DIRECT, INDIRECT, SPECIAL, PUNITIVE OR CONSEQUENTIAL DAMAGES (SUCH AS, BUT NOT LIMITED TO, DAMAGES FOR LOSS OF PROFITS, BUSINESS, SAVINGS, DATA OR RECORDS) CAUSED BY THE USE, MISUSE OR INABILITY TO USE THE PRODUCT. EXCEPT AS STATED HEREIN, NO OTHER WARRANTIES SHALL APPLY. NOTWITHSTANDING THE FOREGOING, CONSUMER'S RECOVERY AGAINST DISTRIBUTOR SHALL NOT EXCEED THE PURCHASE PRICE OF THE PRODUCT SOLD BY DISTRIBUTOR. THIS WARRANTY SHALL NOT EXTEND TO ANYONE OTHER THAN THE ORIGINAL CONSUMER WHO PURCHASED THE PRODUCT AND IS NOT TRANSFERABLE.

Some countries, states or provinces do not allow the exclusion or limitation of incidental or consequential damages or allow limitations on warranties, so limitation or exclusions may not apply to you. This warranty gives you specific legal rights, and you may have other rights that vary from state to state or province to province. Contact your authorized retailer to determine if another warranty applies.



Made in China
02-2022