

### Connecting Audio Devices

Connect one or more audio devices using the MIC input port and attached RCA and 3.5 mm connectors on the transmitter.

- Plug a compatible microphone (*not included*) or any 3.5 mm device into the MIC Input Port on the back of the transmitter.
- Plug the transmitter's attached 3.5 mm connector into any 3.5 mm audio output port, such as a headphone jack.
- Plug the transmitter's attached RCA connector into any RCA audio output port, such as on a TV or stereo.

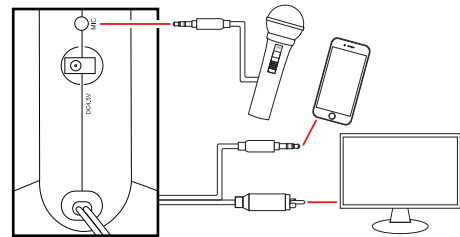

For 2-way audio chat, such as on a PC, you will need a 3.5 mm auxiliary cable (*not included*).

- To receive sound from your computer, plug the transmitter's 3.5 mm aux connector into the computer's audio output.
- To use a microphone, connect a 3.5 mm aux cable (*not included*) to the microphone input port on your computer, and to the MIC input port on the back of the transmitter.

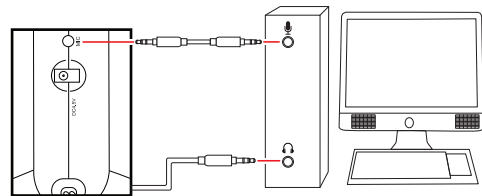

## Safety Information

### READ CAREFULLY AND KEEP THIS MANUAL

#### ⚠ CAUTION

- **THIS IS NOT A TOY, Please keep away from children and pets**
- Keep away from water and extreme temperatures
- Low battery in the headphones or transmitter may cause poor wireless connection or sound distortion
- Do not expose the units to extreme temperatures (heat or cold), open flames, humid conditions, or wet conditions.
- **Do not submerge in water.**
- Do not open this product or attempt to repair the unit yourself should it not be working

#### ⚠ Safety Warnings

- **Do NOT use the wireless headphone receiver to monitor infants, children, elderly persons, persons with disabilities, or any sensitive situation that requires adult supervision.**
- Do NOT use the headphones or listen on high volume, at any time that the inability to hear surrounding sounds may present a danger to yourself or others, such as while riding a bicycle or walking near traffic, a construction site, railroad crossing, etc.
- Do NOT use the headphones at a high volume for any extended period.
- Do NOT use your headphones while driving for phone calls or any other purpose.

### Questions & Customer Support

For questions, troubleshooting or any other assistance, please visit our website at [SouthernTelecom.com](http://SouthernTelecom.com) and click on **Product Support**.

## Compliance Information

### FCC Information

This device complies with Part 15 of the FCC Rules.

**Caution:** Any changes or modifications not expressly approved could void the user's authority to operate the equipment.

**Note:** This equipment has been tested and found to comply with the limits for a Class B digital device, pursuant to part 15 of the FCC Rules. These limits are designed to provide reasonable protection against harmful interference in a residential installation. This equipment generates, uses and can radiate radio frequency energy and, if not installed and used in accordance with the instructions, may cause harmful interference to radio communications. However, there is no guarantee that interference will not occur in a particular installation. If this equipment does cause harmful interference to radio or television reception, which can be determined by turning the equipment off and on, the user is encouraged to try to correct the interference by one or more of the following measures:

- Reorient or relocate the receiving antenna.
- Increase the separation between the equipment and receiver.
- Connect the equipment into an outlet on a circuit different from that to which the receiver is connected.
- Consult the dealer or an experienced radio/TV technician for help.

### Radiation Exposure Information

The device has been evaluated to meet general RF exposure requirement. The device can be used in portable exposure condition without restriction.

### Rating Label Definitions

— Direct current symbol.



This symbol represents FCC Declaration of Conformity and compliance.

## Warranty Information

Territory: United States/Canada

### LIMITED WARRANTY TO ORIGINAL CONSUMER

This product (including any accessories included in the original packaging) as supplied and distributed new by an authorized retailer is warranted by Southern Telecom, Inc. to the original consumer purchaser against defects in materials and workmanship ("Warranty") as follows:

### To obtain warranty service:

- Visit our website at [www.southerntelecom.com](http://www.southerntelecom.com)
- Click on **Product Support**
- Select the **Brand** of your device
- Select **Service Request** and fill out the form to begin your inquiry

Your product will be repaired or replaced, at our option, for the same or similar model of equal value if examination by the service center determines this product is defective. Products received damaged as a result of shipping will require you to file a claim with the carrier.

### Warranty service not provided

This warranty does not cover damage resulting from accident, misuse, abuse, improper installation or operation, lack of reasonable care, unauthorized modification including software modifications such as the installation of custom firmware. This warranty is voided in the event any unauthorized person opens, alters or repairs this product. All products being returned to the authorized service center for repair must be suitably packaged.

NO WARRANTIES, WHETHER EXPRESS OR IMPLIED, INCLUDING, BUT NOT LIMITED TO, ANY IMPLIED WARRANTIES OF MERCHANTABILITY OR FITNESS FOR A PARTICULAR PURPOSE, OTHER THAN THOSE EXPRESSLY DESCRIBED ABOVE SHALL APPLY. DISTRIBUTOR FURTHER DISCLAIMS ALL WARRANTIES AFTER THE EXPRESS WARRANTY PERIOD STATED ABOVE. NO OTHER EXPRESS WARRANTY OR GUARANTEE GIVEN BY ANY PERSON, FIRM OR ENTITY WITH RESPECT TO THE PRODUCT SHALL BE BINDING ON DISTRIBUTOR. REPAIR, REPLACEMENT, OR REFUND OF THE ORIGINAL PURCHASE PRICE - AT DISTRIBUTOR'S SOLE DISCRETION - ARE THE EXCLUSIVE REMEDIES OF THE CONSUMER. IN NO EVENT WILL DISTRIBUTOR OR ITS MANUFACTURERS BE LIABLE FOR ANY INCIDENTAL, DIRECT, INDIRECT, SPECIAL, PUNITIVE OR CONSEQUENTIAL DAMAGES (SUCH AS, BUT NOT LIMITED TO, DAMAGES FOR LOSS OF PROFITS, BUSINESS, SAVINGS, DATA OR RECORDS) CAUSED BY THE USE, MISUSE OR INABILITY TO USE THE PRODUCT, EXCEPT AS STATED HEREIN. NO OTHER WARRANTIES SHALL APPLY. NOTWITHSTANDING THE FOREGOING, CONSUMER'S RECOVERY AGAINST DISTRIBUTOR SHALL NOT EXCEED THE PURCHASE PRICE OF THE PRODUCT SOLD BY DISTRIBUTOR. THIS WARRANTY SHALL NOT EXTEND TO ANYONE OTHER THAN THE ORIGINAL CONSUMER WHO PURCHASED THE PRODUCT AND IS NOT TRANSFERABLE.

Some countries, states or provinces do not allow the exclusion or limitation of incidental or consequential damages or allow limitations on warranties, so limitation or exclusions may not apply to you. This warranty gives you specific legal rights, and you may have other rights that vary from state to state or province to province. Contact your authorized retailer to determine if another warranty applies.

2019 Sharper Image® name and logo are registered trademarks. Manufactured, marketed, and distributed under license by Southern Telecom, Inc. Brooklyn, NY 11220.  
© Sharper Image. All Rights Reserved.

All product names, trademarks, and registered trademarks are property of their respective owners. All company, product, and service names used in this document are for identification purposes only. Use of these names, trademarks, and brands does not imply endorsement.



## Instruction Manual ASOTV-TVHP

Printed in China  
Designed in USA  
v1. 04-2019

## Before You Begin...

### ⚠ CAUTION

- **THIS IS NOT A TOY.** Please keep away from children and pets
- Read Safety Information at the end of this manual before using

### In the Box

- ASOTV-TVHP - Wireless Headphones (x1)
- Wireless Transmitter (x1)
- Instruction Manual (x1)

### Location of Controls

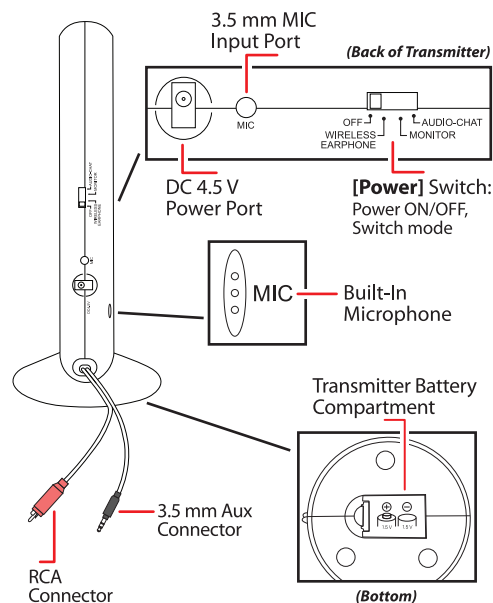

## Location of Controls (cont.)

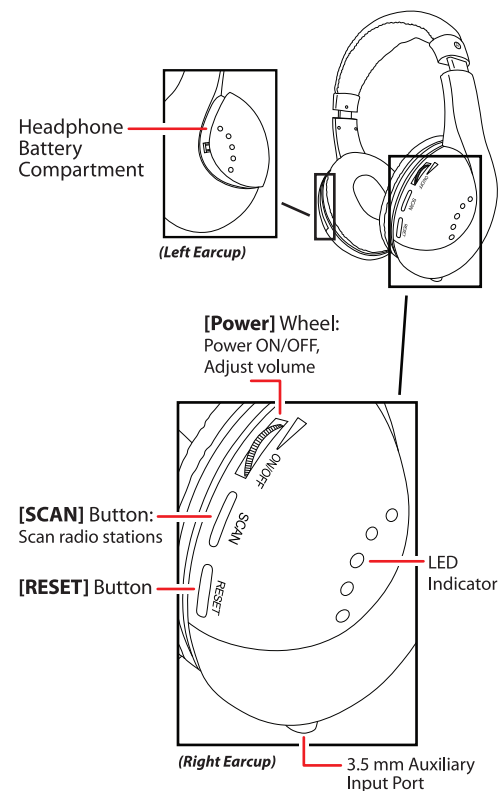

## Getting Started

### Listening Wirelessly

1. Set up the headphones and transmitter, installing batteries if necessary, and connecting your audio devices. Consult the later sections of this guide for detailed setup instructions.
2. Move the **[Power]** switch on the back of the transmitter to power the transmitter ON and select a mode. An LED indicator on the front of the transmitter will light up red.
  - Select **[WIRELESS EARPHONE]** mode to listen to a device connected to the transmitter.
  - Select **[AUDIO-CHAT]** mode for two-way communication, such as chatting on a PC. See the **Connecting Audio Devices** section of this guide for special setup instructions.
  - Select **[MONITOR]** mode to listen to audio picked up by the transmitter's built-in microphone.

**Warning:** It is NOT recommended to use **[MONITOR]** mode for monitoring infants, children, or any sensitive situation that requires adult supervision.

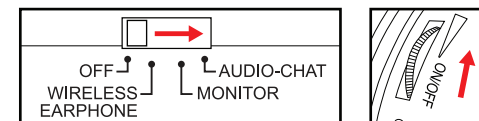

3. Power the headphones ON by pushing the **[Power]** wheel on the right earcup **up** until it clicks. The red LED indicator on the headphones will light up to indicate that they are powered on.
4. Press the **[RESET]** button on the headphones' right earcup. Then, press the **[SCAN]** button. After a moment, you should hear your audio. If not, power the transmitter and headphones OFF, check their connections, and repeat steps 2-4.

### Listening to FM Radio

1. Power the transmitter OFF.
2. With batteries installed, power the headphones ON.
3. Press the **[RESET]** button once. You should hear FM radio.
  - Press the **[SCAN]** button to skip to the next available FM station.
  - Press **[RESET]** to reset back to the lowest frequency FM station.

### Using the Headphones

The headphones can be used wirelessly by inserting batteries, or without batteries using a 3.5 mm aux cable (*not included*).

When using wirelessly, power the headphones ON by pushing the **[Power]** wheel on the right earcup up until it clicks. The LED indicator on the right earcup will light up red.

### Installing Headphone Batteries

1. Pull the battery cover on the left earcup **up and to the right**, as shown in the diagram, to remove.
2. Insert 2 new 1.5V AAA-sized Alkaline batteries (*not included*) following the polarity (+/-) diagram on the battery cover. Do not mix old and new batteries or different types or brands of battery.
3. Slide the battery cover back into place on the left earcup.

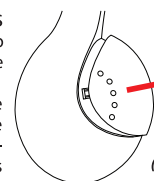

### Listening with a Wired Connection

You do not need to install batteries, power the headphones on, or use the transmitter when listening over a wired connection.

Plug one end of a 3.5 mm auxiliary cable (*not included*) into the 3.5 mm auxiliary input port on the bottom of the headphones' right earcup. Plug the other end into the output port on your MP3 player or other audio device.

In this mode, all playback and volume adjustment will be controlled by your connected device.

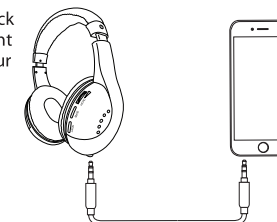

### Setting Up the Transmitter

1. Choose a location. The transmitter will have best reception at a higher position, with a clear line of sight to the sky.
2. Install batteries in the transmitter or connect it to AC power using a **compatible** DC 4.5 V power adapter (*not included*). See the **Installing Transmitter Batteries** and **Using a Power Adapter** sections below for instruction.
3. Connect audio devices using the built-in port and connectors on the back of the transmitter. Consult the **Connecting Audio Devices** section of this guide for specific instruction.

### Installing Transmitter Batteries

The transmitter can be used wirelessly by installing batteries.

1. On the bottom of the transmitter, pinch the clasp of the battery cover and pull to remove.
2. Insert 2 new AAA-sized Alkaline batteries (*not included*) following the polarity (+/-) diagram on the battery cover. Do not mix old and new batteries, or mix different types or brands of battery.
3. Slide the back of the cover back into the battery cover slot and push closed until the clasp clicks.

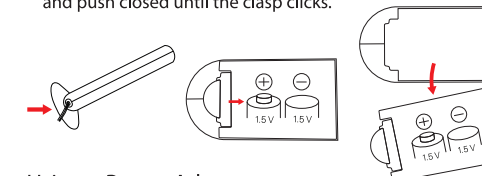

### Using a Power Adapter

The transmitter can be used without batteries by connecting to AC power with a **compatible DC 4.5 V Adapter** (*not included*).

Plug the small connector of a compatible adapter into the DC 4.5 V Power Port on the back of the transmitter. Plug the other end into a nearby wall socket.

**⚠ Warning:** Using an incompatible power adapter can cause serious injury or damage.